



THANE ^{#HOUSEWARES™}



TURBO

USER'S GUIDE



THANE ^{#HOUSEWARES™}



Thane International, Inc.,
La Quinta, CA 92253
www.thane.com

Thane Direct Canada, Inc.,
Toronto, ON
www.thane.ca

Thane Direct UK Ltd.,
Admail ADM3996, London,
W1T 1ZU
www.thanedirect.co.uk

MADE IN CHINA, THANE HOUSEWARES is a registered trademark of Thane International, Inc.
Copyright, ©2007 by THANE INTERNATIONAL, INC

FWOT-ENG-CAN 02/09/09



FlavorWave
OVEN®

TURBO

FlavorWave
OVEN®

TURBO

Thank You...

On behalf of the entire team at Thane Housewares, we appreciate your recent purchase of the FLAVORWAVE OVEN® TURBO.

This cooking system will provide you with healthy and tasty meals for many years to come.

We worked long and hard to make this the best cooking appliance available and, only after extensive testing, added it to our family of quality products for the home.

Enjoy your FLAVORWAVE OVEN® TURBO.

... and, once again, thank you.

ONE YEAR LIMITED WARRANTY

Thank you for your purchase of the amazing Flavorwave Turbo. With this warranty, the Flavorwave Turbo is warranted, to the original owner, for one (1) year from the date of purchase against defects in material and workmanship under normal use and service. Should your Flavorwave Turbo prove defective within one (1) year from date of purchase, return the defective part or unit, freight prepaid along with an explanation of the claim to Flavorwave Turbo.

Please package your Flavorwave Turbo carefully to avoid damage in transit. Under this warranty, Thane Direct, will repair or replace any parts found to be defective. This warranty is effective only if the product is purchased and operated in Canada. This warranty extends only to personal use and does not extend to any product that has been used for which it is not intended. There are no warranties other than that expressly set forth herein. This warranty is not transferable. After the expiration of the warranty, the cost of the labor and parts will be the responsibility of the original purchaser.

Thane Direct, is not responsible or liable for indirect, special or consequential damages arising out of or in connection with the use or performance of the product or other damages with respect to any economic loss, loss of property, loss of revenues or profits, loss of enjoyments or use, costs of removal, installation, other consequential damages of whatsoever nature, failure to follow instructions or warnings in owner's manual or use of products in a manner for which they were not designed. Some Provinces do not allow the exclusion or limitation of incidental or consequential damages. Accordingly, the above limitation may not apply to you. This warranty gives you specific legal rights. You may also have other rights, which vary from Province to Province.

THIS WARRANTY DOES NOT APPLY TO THE FOLLOWING:

1. Damage due to accident, misuse, abuse, commercial use or vandalism.
2. Improper or inadequate maintenance.
3. Unauthorized modification or commercial use.
4. Damage in return transit.
5. "Normal" wear of parts (wear and tear that occurs over time and with use).
6. Repairs made by an unauthorized service technician.

TO OBTAIN SERVICES - The original purchaser shall contact our customer service representative via e-mail at cs@thane.ca or by phone at **1-866-338-4263** and depending on the extent of the service required, the purchaser shall have the obligations and responsibility to:

- Pay for all services and parts not covered by the limited warranty.
- Include a cheque in the amount of \$14.95* to cover the shipping and handling, payable to "Flavorwave Turbo".
- Carefully package the product using adequate padding material to prevent damage during transit. The original packaging is ideal for this purpose.
- Include in the package: the owner's name, address, telephone #, and a detailed description of the problem.
- Provide the proof of purchase, which includes date of purchase.
- Send via Insured* Parcel Post or courier to:

Flavorwave Turbo
C/O Northland Fulfillment Inc.
101 Canarctic Drive
North York (Ontario) M3J 3N1
CANADA

FOR ALL INQUIRES, PLEASE CONTACT OUR CUSTOMER SERVICE VIA E-MAIL AT CS@THANE.CA OR BY PHONE AT 1-866-338-4263 ANY TIME M-F FROM 9:30-5:30 EST.

* Thane Direct Canada, Inc. is NOT responsible for any non-insured items lost in transit.



TROUBLE SHOOTING GUIDE

SYMPTOM & PROCEDURES	
<p><i>OVEN WILL NOT TURN ON</i></p>	<ul style="list-style-type: none"> • Check to see that the power cord is plugged into AC outlet. • Check to see that the AC outlet is operational. • Turn the timer knob clockwise to 60 min and then turn back to the desired time. • Check that the thermostat is set to desired temperature. • Push the carry handle all the way down. NOTE: This handle acts as a safety switch and will not allow the oven to work when in the up-right position.
<p><i>OVEN WILL NOT HEAT UP</i></p>	<ul style="list-style-type: none"> • Check if the power switch is in ON position. (For AX797DH-Platinum only)
<p><i>LID OR GLASS BOWL IS CRACKED</i></p>	<ul style="list-style-type: none"> • Check the thermostat to see that it is set for a high enough temperature. • Order replacement part from the service department.

FEATURES	
<p><i>TECHNICAL SPECIFICATIONS</i></p>	
Weight :	21 lbs.(9.5 kg)
Bowl Diameter :	12 in.(305 mm)
Bowl Capacity :	12 qrts.(11.0 liters)
Bowl Depth :	6.6 in. (167 mm)
Cook Temp. Range :	65°C-260°C (150°F-500°F)
Voltage/Cycles :	110V/120V, 60Hz 220V - 240V, 50/60Hz
Wattage :	1300W

TABLE OF CONTENTS

I.	Introduction	6
	Important Safeguards	4 - 5
II.	Using Your Oven	7
	Product and Accessory Diagrams (AX-767MH)	7 - 8
	Part Assembly Diagram	9
	Before You Begin Cooking	10
	How to Operate the FLAVORWAVE Turbo (AX-767MH)	11 - 12
	Cleaning Your Oven	12 - 13
	Product Diagrams FLAVORWAVE Turbo Platinum (AX-797DH)	14
	How to Operate the FLAVORWAVE Turbo Platinum (AX-797DH)	15 - 16
III.	Helpful Hints	17
	A Healthier Lifestyle	17
	Cooking Tips	17 - 18
	Selecting Your Food	19
	Food Preparation and Presentation	20
V.	Quick Reference Guide	21
	Trouble Shooting Guide	22



IMPORTANT SAFEGUARDS

When using electrical products, especially when children are present, basic safety precautions should always be followed, including the following:

Read all instructions, safeguards, and warnings before using the appliance.

A To reduce the risk of burns, electrocution, fire, or injury to persons.

1. Read all instructions.
2. Do not place appliance where it can fall or be pulled into water or other liquid.
3. Do not reach for an appliance that has fallen into water. Unplug immediately!
4. Always pull handle up to "off" position before plugging or unplugging oven.
5. Place oven securely in center of counter or work space.
6. Always unplug oven before attempting to move it.
7. Secure the FLAVORWAVE OVEN® TURBO lid on the oven before turning on power.
8. Always turn oven off before removing lid and always place lid on the lid rack. Never set it down directly on the counter. Always leave at least 2 inches between the oven lid and counter top or other surfaces.
9. Use two hands when moving the oven.
10. Do not allow the lid to get wet.
11. The oven can not be placed near the wall (while using)
12. Do not touch the glass bowl and lid or any surfaces on the heater assembly during operation. The air inside the cooking dome reaches a temperature of approximately 260°C/500°F which makes the surface very hot and may cause burns.
13. This appliance is not intended for use by persons (including children) with reduced physical, sensory or mental capabilities, or lack of experience and knowledge, unless they have been given supervision or instruction concerning the use of the appliance by a person responsible for their safety.
14. Children should be supervised to ensure that they do not play with the appliance.
15. Use this appliance for its intended use as described in this brochure. Do not use any other accessories or attachments not recommended by the manufacturer. They may result in fire, electrical shock, or personal injury.
16. Never operate this appliance if it is not working properly, if it has been dropped or damaged, or dropped into water. Return the appliance to an authorized customer service center for inspection, repair, or adjustment.
17. • For FLAVORWAVE Oven Turbo model **AX767MH**: If the supply cord is damaged, it must be replaced by the manufacturer, its service agent or similarly qualified persons in order to avoid a hazard.
• For FLAVORWAVE Oven Turbo Platinum model **AX797DH**: If the supply cord is damaged, please order cord replacement from customer service where you purchased the product.

QUICK REFERENCE GUIDE

- Listed cooking time is for reference only • Depending on recipe and food type, food should be flipped during the cooking cycle.
- Cooking time may vary depending on food type, weight, volume and texture

ITEMS	COOKING TIME	FOOD INTERNAL TEMP.		OVEN TEMP. SETTING	COOKING & SERVING TIPS
		Fresh Food	Frozen Food		
MEATS AND FISH					
Beef Rib Roast	28 minutes per pound (medium-rare)	63°C (149°F)	205°C (400°F)	Grill on lower rack, top with tomato paste	
Meat Loaf (2 pound)	31 minutes per pound (medium)	71°C (160°F)	205°C (400°F)	Grill on lower rack, top with tomato paste	
Hamburgers - 4 Burgers (1/4 pound each)	50 to 60 minutes	73°C (163°F)	175°C (350°F)		
Hot Dogs (11/2 to 2 ounces each)	16 minutes (rare)	65°C (149°F)	205°C (400°F)	Upper rack	
Hot Dogs (11/2 to 2 ounces each)	18 minutes (well done)	70°C (158°F)	205°C (400°F)	Upper rack	
Hot Dogs (11/2 to 2 ounces each)	20 minutes (well done)	75°C (167°F)	205°C (400°F)	Upper rack	
Hot Dogs (11/2 to 2 ounces each)	10 minutes				
Hot Dogs (11/2 to 2 ounces each)	26 minutes (10 min per side) - (rare)	65°C (149°F)	205°C (400°F)	Upper rack	
Hot Dogs (11/2 to 2 ounces each)	31 minutes (12 min per side) - (medium)	70°C (158°F)	205°C (400°F)	Upper rack	
Hot Dogs (11/2 to 2 ounces each)	26 minutes	65°C (149°F)	205°C (400°F)	Upper rack	
Hot Dogs (11/2 to 2 ounces each)	12 to 14 minutes	65°C (149°F)	205°C (400°F)	Upper rack	
Lobster Tails	18 minutes	65°C (149°F)	205°C (400°F)	Peel and place 6 to 8 shrimp on each skewer	
Pork Loin Roast	29 minutes per pound	73°C (163°F)	185°C (360°F)	Split and discard undershell. Upper rack	
Pork Chops (1/2 inch thick)	10 to 16 minutes	73°C (163°F)	240°C (460°F)	Bottom rack	
Sausage Patties (1 pound)	16 minutes	73°C (163°F)	200°C (390°F)	Upper rack	
Leg of Lamb	Rare-26 minutes per pound	65°C (149°F)	200°C (390°F)	Upper rack	
	Medium-31 minutes per pound	70°C (158°F)	200°C (390°F)	Cook at 240°C for first 20 minutes	
	Well-36 minutes per pound	75°C (167°F)	200°C (390°F)		
Lamb Chops	21 minutes (medium)	71°C (160°F)	205°C (400°F)		
Breaded Fish (Frozen)	11 to 13 minutes less than package directs	65°C (149°F)	175°C (350°F)	Grill on upper rack	
Bacon (1 pound)	12-16 minutes		175°C (350°F)	Grill on lower rack	
CHICKEN (3 1/2 pound)					
Quarter	31 minutes	82°C (180°F)	240°C (460°F)	Lower rack. Brush with sauce, if desired, in last 10 minutes	
Whole	21 minutes	82°C (180°F)	240°C (460°F)	Lower rack	
Wings	25 minutes	82°C (180°F)	240°C (460°F)	Lower rack	
Chicken Breasts	26 to 31 minutes	82°C (180°F)	240°C (460°F)	Season before Roasting	
Turkey (Un-stuffed)	26 to 31 minutes per pound	82°C (180°F)	240°C (460°F)	Season before Roasting	
Turkey Breast (Half-3 pounds)	45 to 60 minutes	82°C (180°F)	240°C (460°F)	Season before Roasting	
Cornish Hens	26 minutes per pound	82°C (180°F)	240°C (460°F)		
VEGETABLES					
Baked Potato (6 to 8 ounces)	41 minutes	85°C (185°F)	205°C (400°F)	Lower rack. Spray rack with non-stick coating	
Corn on the Cob (4 ears) Unshucked	26 minutes	60°C (140°F)	205°C (400°F)	Lower rack. Unshucked and soak in water	
French Fries	16 minutes or until crisp (spray lightly with oil to make fries browner)	85°C (185°F)	230°C (450°F)	Lower rack. Spray rack with non-stick coating	



TURBO



TURBO

FOOD PREPARATION & PRESENTATION

PREPARATION

Careful preparation pays off in an appetizing, healthy and tasty meal(s). Always remove excess fat. Clean and trim vegetables and garnishes, removing all bruises and blemishes. Use only the freshest meats and vegetables. Always ensure that all items of the meal are cooked at the right time. This usually requires different starting times that must be planned ahead.

PRESENTATION

Try a few of these interesting ways to perk up your table and make any meal a festive occasion:

- Slice a freshly baked loaf of bread or dinner rolls into a basket lined with colorful napkins. Serve with butter or margarine, softened and mixed with grated cheese, garlic salt or your favorite seasoning.
- Main course meats are more attractive when displayed on a large platter surrounded by fresh parsley sprigs, carrot curls (made with a potato peeler) and radish roses.
- Serve sauces in a pretty piece of china or glassware. Drop in a ladle and bring to the table on a plate for easier passing between guests.
- Flowers on the table are always effective, but in a pinch use a grouping of your favorite figurines or house plants.
- Candles make dinners cozy, so turn down the lights and turn up the charm. Float small, flat candles in a large, clear bowl filled with water. The effect is magical.

18. Do not use outdoors or operate where aerosol (spray) products are being used or where oxygen is being administered.
19. Do not let the cord hang over the edge of the table or counter, or touch hot surfaces.
20. Do not place on or near a hot gas or electric burner or in a heated oven.
21. Do not move the appliance while it contains hot food. Use extreme caution when removing hot lid, glass bowl and cooking racks.
22. This appliance is for household use only; it is designed to process normal household quantities. It is not suitable for continuous or commercial operation.
23. Do not disassemble the product. There are no user serviceable parts.
24. Do not leave the appliance unattended while in use.
25. Use the handle when lifting the lid from the base.
26. Do not touch hot surfaces. Use the handles provided.
27. Turn the unit "off" before removing the lid to check or turn food. The lid and heater/control assembly should be placed on the lid holder.
28. Use caution when disposing of hot grease.
29. This appliance is not intended to be operated by means of an external timer or separate remote-control system.
30. To protect against electrical shock do not immerse cord, plugs, or lid in water or other liquid.
31. Always attach plug to appliance first, then plug cord into the wall outlet. To disconnect, turn any control to "off", then remove plug from wall outlet.
32. Unplug from outlet when not in use and before cleaning. Allow to cool before putting on or taking off parts.
33. Do not operate any appliance with a damaged cord or plug or after the appliance malfunctions or has been damaged in any manner. Return appliance to the nearest authorized service facility for examination, repair, or adjustment.
34. The use of accessory attachments not recommended by the appliance manufacturer may cause injuries.
35. Extreme caution must be used when moving an appliance containing hot oil or other hot liquids.
36. Do not use appliance for other than intended use.
37. **FOR 120V Unit Only:** This appliance has a polarized plug (one blade is wide than the other). As a safety feature, this plug will fit in a polarized outlet only one way. If the plug does not fit fully in the outlet, reverse the plug. If it still does not fit, contact a qualified electrician. Do not attempt to defeat this safety feature.

HOUSEHOLD USE ONLY

SAVE THESE INSTRUCTIONS



TURBO



TURBO

I. INTRODUCTION

THE FLAVORWAVE OVEN® TURBO STORY

THE NEXT GENERATION IN COOKING™

With the FLAVORWAVE OVEN® TURBO you can prepare delicious, healthful meals in less than half the time of traditional methods. What makes these superior results possible is our revolutionary approach to certain time-honored cooking methods.

Professional cooks have long known that they could improve upon traditional oven cooking by using a fan to accelerate the circulation of the oven's hot air. This traditional convection oven consists of a fan mounted on one side of a metal box.

The FLAVORWAVE OVEN® TURBO improves upon traditional convection ovens in the following ways:

- The FLAVORWAVE OVEN® TURBO bowl is made of glass, not metal, so that you can clearly see what you are cooking from all sides.
- The FLAVORWAVE OVEN® TURBO combines a circular bowl with a fan mounted in the lid so that hot air currents move down over the food, around the bowl's sides, and then back up to the fan. This creates a tornado-like flow of constantly moving, super-heated air that cooks and browns food quickly and thoroughly.
- The FLAVORWAVE OVEN® TURBO uses cooking racks that allow you to cook two levels of food at once. In addition, when meat, poultry, or fish is cooked on the lower rack, fats and oils are blown away through the grating. You will cook lighter, more nutritious meals.

SELECTING YOUR FOOD

MEAT

Beef : Select rich, red, fine-textured meat with a light covering of fat (having a marbled appearance). Buy whole pieces and cut to suit – you can really save a lot.

Lamb : Select lean meat. Meat should be soft, pinkish-red and fine textured.

Pork : Select lean meat. Meat should be very light pink in color, fine textured and fresh smelling.

FISH

Whole : Select only fresh fish with full, clear eyes and bright gills - a sure sign of freshness. Also, scales should be bright and clean – not slimy. Fish should look and smell fresh from the sea. Flesh should be firm and spring back when touched.

Fillets : Select only firm fillets without discoloration that have a pleasant sea smell. Fillets must not be dull, soft or ooze water when touched.

POULTRY

Select only fresh meat or birds. Poultry should look and smell fresh.

VEGETABLES / FRUIT

Select firm, almost ripe fruit; check for bruises and blemishes – color should be clear and bright. Vegetables should be crisp and of good color. Try to avoid vegetables sold tightly packed in plastic wrap - they will spoil quickly. Never use vegetables that are soft or limp.



TURBO



TURBO

• COOKING A COMPLETE MEAL AT ONCE

By using two levels of racks, it is easy to cook an entire meal at once. Keep in mind that different foods and different weights of foods take different amounts of time to cook. Think ahead. Put the food that takes the longest amount of time to cook on the low rack.

Later on during the cooking process, put the other food on the high rack. Now your complete meal of meat, potatoes and vegetables are all cooked together and will be ready at the same time.

• PLACING FOODS FOR OPTIMUM COOKING

When placing several pieces of food on the wire rack, be sure to leave at least 1/2-inch between the food and the side of the glass bowl. This space allows the air to flow freely through the oven.

Also avoid stacking food on food in order to cook more at one time. The hot air must circulate freely in order to cook the food properly.

• KEEPING FOOD CRISP

After the food is cooked, turn the thermostat down, keeping the fan running. Your food will stay hot and crisp.

• TO MAKE YOUR CLEAN-UP EVEN EASIER

Before cooking, spray the oven, including the racks and pans, with a non-stick product first. Wiping away the grease and residue after cooking will be even easier.

• ADAPTING RECIPES

As a rule of thumb, when using recipes intended for conventional ovens, temperatures will remain the same but cooking times will be less. The cooking times in the recipes in this book should be used as a guide. You need to judge whether your piece of meat weighs less or more than that which is used in the recipe and slightly adjust your cooking time. When working with the FLAVOR WAVE OVEN® TURBO for the first time, we suggest using a meat thermometer. Watch the cooking progress through the glass bowl. After a short time you will easily be able to adapt your favorite recipes for the FLAVOR WAVE OVEN® TURBO.

• PREHEAT YOUR OVEN (when it is recommended by the recipe book)

For optimum cooking, preheat your oven at 260°C/500°F for six (6) minutes prior to cooking.

• COOKING TIME

Cooking times shown in this manual will vary depending on the volume, weight and mass of the food or the desired crispness you want.

• CORN SHOULD NOT BE SHUCKED PRIOR TO COOKING.

II. USING YOUR FLAVORWAVE OVEN® TURBO

PRODUCT & ACCESSORY DIAGRAM

**FLAVORWAVE OVEN® TURBO
(AX-767MH)**



STANDARD ACCESSORIES

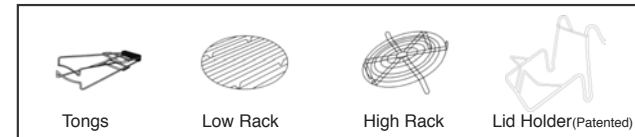







FlavorWave
OVEN®

TURBO

FlavorWave
OVEN®

TURBO

OPTIONAL ACCESSORIES

 <p>Grilling Plate</p>	<p>Coated with non-stick material, is designed for grilling. Position the grilling plate on the high rack and heat at max temperature for about 5 min then put pieces of cooked meat on it and you will sear the lines just like on your outdoor BBQ.</p>	 <p>Steam Basket</p>	<p>Can be used for steaming vegetables... for baking French fries without grease... for steaming fish wrapped with aluminum foil etc.</p>
 <p>Browning Tray</p>	<p>Is a special accessory for your Flavorwave Turbo Oven. It serves the purpose of browning, or making food crisp by oxidizing.</p>	 <p>Breakfast Tray</p>	<p>Is ideal for preparing your favorite breakfast, just place pieces of toast bread, bacon and eggs on the rack and cook at the same time.</p>
 <p>Extender Ring</p>	<p>The Flavorwave Turbo Extender Ring makes it possible to cook larger turkeys, chickens, hams etc. Insert the Extender Ring between the glass bowl and the lid and increase the height of the Flavorwave Turbo bowl by an additional 3" (9 cm)</p>	 <p>Quick Skillet with non-stick coating</p>	<p>Place the Quick Skillet onto the metal skillet holder, put the FlavorWave Oven Turbo lid with halogen heater on top and you are ready to prepare your quick skillet dishes. Please refer to the "How to operate the FlavorWave Oven Turbo Instructions" to set temperature and time.</p>
 <p>Roast Rack</p>	<p>When roasting a whole turkey/chicken you may use the Roast Rack. Place the Roast Rack on the High Rack and then position a whole turkey/chicken. Note: Must be used with the Extender Ring.</p>		

Roasting Rack - How to Assemble

- The Roasting Rack is two separate pieces of metal (Fig. 1).
- At top, metal piece has a hole (left).
- At top, piece curves up (right).
- Take the right piece and thread an end through hole of left piece. The curved top section should be stationed in hole of left piece.
- To position the Roasting Rack onto the High Rack, attach the ends of the Assembled Roasting Rack to the designated curves on the High Rack (Fig. 2).

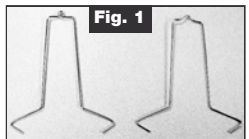

Fig. 1

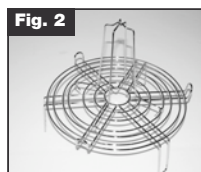

Fig. 2

Chicken, roasting hens, etc... are placed over joined metal pieces (Roasting Rack).

III. HELPFUL HINTS

A HEALTHIER LIFESTYLE

With the FLAVORWAVE OVEN® TURBO, you are always cooking with hot air (dry roasting) and with the food suspended on a wire rack. As a result, retention of fat is minimized, leading to fewer calories, lower fat and cholesterol consumption and a healthier lifestyle.

You will find that, with the FLAVORWAVE OVEN® TURBO, it is not necessary to add fat, oil, butter or margarine to most recipes. However, you can do so if you wish.

We recommend the following steps to further improve your health:

1. Eat a variety of foods including items from all food groups daily.
2. Eat less butter, fat and sauces.
3. Eat less sugar and sweets.
4. Eat plenty of fruits and vegetables (preferably steamed).
5. Drink only moderate amounts of alcohol.
6. Drink plenty of water every day.
7. Use less processed foods-eat more fresh food instead.
8. Eat less at a time, but eat regularly.
9. Use fat, oil, butter and margarine sparingly.
10. Use salt sparingly.
11. Dry roast your food as often as possible.

COOKING TIPS

TO USE YOUR FLAVORWAVE OVEN® TURBO TO ITS FULLEST POTENTIAL, HERE ARE A FEW COOKING TIPS TO REMEMBER...

- **DEPENDING ON RECIPE AND FOOD TYPE, WEIGHT, VOLUME AND TEXTURE, FOOD SHOULD BE FLIPPED DURING THE COOKING CYCLE.**
- **WHENEVER POSSIBLE PLACE FOOD DIRECTLY ON THE WIRE RACK**
Cooking on a wire rack allows the hot air to circulate freely around the food, cooking it quickly and evenly, even without turning.



TURBO



TURBO

7. Select Fan Speed: Press the "Speed" button to change the fan speed. The indicator light will move from left to right. Once "High" is reached the cycle will start over again at "Low". "High" fan speed (recommended) helps the food cook faster, and improves browning. For slower cooking you may use "Medium" or "Low" fan speed. (Note: you may change the fan speed during cooking by pressing the "Speed" button).
8. To begin cooking, press the "Start" button. The unit will not operate unless time, temperature and fan speed are set and safety handle (or lid) is down. **NOTE:** During cooking time, when the oven reaches the preset temperature, it will shut off then it will start again automatically (this is normal).
9. When the timer reaches "00:00", the cooking cycle is finished and the appliances will beep 6 times. At the same time, the power light goes off but the temperature indicator light is still on. If the oven temperature is over 150°C (300°F), the fan speed indicator light will flash and the fan will continue to operate to allow the heating element to cool. When the oven temperature drops down to 150°C (300°F), the fan will stop operating and the fan speed indicator light will stop flashing.
10. Press the "Clear" button to reset all functions. The timer will be reset to "00:00", temperature indicator light shut off and timer will stop. The fan will stop operating while the oven temperature is below 150°C (300°F). However, if the oven temperature is over 180°C (350°F), the fan speed will switch to low speed and start to dissipate heat. At the same time, the speed indicator light stays at the original position and flashes until the oven temperature is dropped down to 150°C (300°F).
11. When the oven temperature reaches the selected temperature during cooking. The temperature indicator light will flash. However, when the oven temperature drops below the selected temperature, the light will stay at "on" again without flashing.
12. Thaw Function: The Thaw setting allows thawing for delicate foods and particularly those items which require gentle defrosting. Rather than leaving them on a benchtop they may be defrosted in the closed hygienic environment of the Oven.

How to use Expansion Device:

1. Press the safety button and hold at its release position as illustrated in 1, fig.6.
2. Press the push button upward and lift the lid to extended position as illustrated in 2, fig.6.

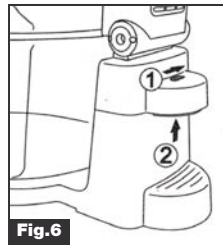
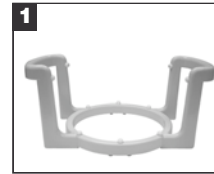

Fig.6

! Do not press the safety button when moving or holding the appliance.

CLEANING Your Flavorwave Oven® Turbo Platinum:
Refer to **CLEANING YOUR OVEN** section in this manual.

PART ASSEMBLY DIAGRAM



Remove the glass bowl and base plate from the bowl holder.
(for 220-240V only)



Put the glass bowl holder upside-down and screw the safety block to the underside of the bowl holder.
(for 220-240V only)

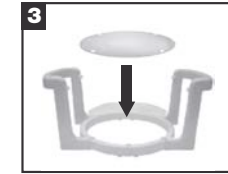

Put the glass bowl holder on a firm surface such as kitchen countertop and place the base plate on the bowl holder.



Place the glass bowl inside the bowl holder.

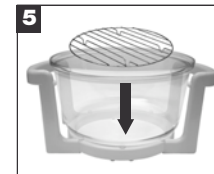

Place wire rack(s) inside the glass bowl.



Place the lid on the glass bowl.



Assembly is now complete.



Note: The safety block is designed to assure that the FWOT doesn't get too close to the adjacent wall or objects. When using the FWOT please make sure to position the oven in such a way that the safety block is always placed between the FWOT and the wall behind it as illustrated in Fig. 8.
(for 220-240V only)



TURBO



TURBO

BEFORE YOU BEGIN COOKING

PREPARING YOUR FLAVORWAVE OVEN® TURBO

! FOR THE FIRST TIME ONLY

The FLAVORWAVE OVEN® TURBO should be heated once before cooking with it. While preparing the oven according to the following instructions, the oven will give off a slight burning odor. The oven is actually burning off excess lubricants found in the oven's heating elements and will not harm you or the oven.

FOLLOW THESE EASY STEPS...

- Wipe the inside of the glass bowl with a damp sponge
- Secure lid on oven
- Set timer for 5 minutes
- Set thermostat to 260°C/500°F and turn oven on
- After timer has shut oven off, allow to cool for 5 minutes
- Wipe inside of the glass bowl with a damp sponge a second time

NOW YOUR FLAVORWAVE TURBO OVEN IS READY TO COOK YOUR FIRST MEAL!

IMPORTANT:
DO NOT WASH OR IMMERSE THE LID IN WATER OR IN DISHWASHER. THE OUTER SURFACE CAN BE CLEANED BY WIPING CAREFULLY WITH A DAMP DISH-CLOTH OR SPONGE.



For Model AX767MH. If the supply cord is damaged, it must be replaced by the manufacturer, its service agent or similarly qualified persons in order to avoid a hazard.

HOW TO OPERATE THE FLAVORWAVE OVEN® TURBO PLATINUM (AX-797DH)

OPTIONAL ITEM



1. Plug one end of Power Cord into back of lid (AX-797DH) and the power plug in a standard AC outlet. Turn the power switch to the ON position.
2. The digital timer will display "00:00", temperature indicator light will stay at 65°C (wash) and the fan speed indicator light at "High". If not, press "Clear" button to bring out the above status.
 Note: Please allow time tolerance of 5-7 min for 60 min timer setting.
3. Place lower wire rack in the glass bowl of the oven. (Note: Use the lower rack for all recipes unless otherwise noted). Place food directly on rack unless otherwise specified.
4. **If the recipe required preheating, follow this procedure:**
 Press the "Pre-Heat" button. this will cause the oven to operate at its highest temperature and fan speed for 6 minutes. Preheating is complete when the timer reaches "00:00" and the fan light flashes. Press the up arrow to increase the preheating time, if needed.
5. Time Selection: press the "+" or "-" buttons lightly to raise or lower the time selected in increments of 1 minute up to 23 hours and 59 minutes. Holding the "-" button will cause the increment more quickly. The "Clear" button will reset the timer to zero. (Note: you may change the cooking time during cooking by pressing the "+" or "-" buttons).
6. Temperature Selection: Press the "Temp" button gently to move the temperature selector through the temperatures one at a time from left to right. A light will indicate the selected temperature. Once 260°C (500°F) is reached the cycle will start all over again at "wash" (Note: you may change the temperature setting during cooking by pressing the "Temp" button).

FlavorWave
OVEN™

TURBO

FlavorWave
OVEN™

TURBO

FLAVORWAVE OVEN® TURBO PLATINUM

PRODUCT & ACCESSORY DIAGRAM

FLAVORWAVE OVEN® TURBO PLATINUM (AX-797DH)

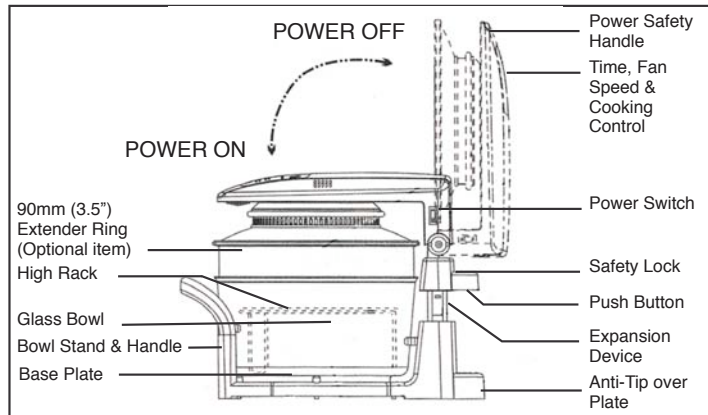

HOW TO OPERATE THE FLAVORWAVE OVEN® TURBO (AX-767MH)

1. Attach the Lid Holder as illustrated in fig. 1.
2. Place either the low or the high rack inside the glass bowl of the oven.
NOTE : Use the lower rack for all recipes unless otherwise noted.
3. Place food directly on rack, unless otherwise specified.
4. Secure lid on oven.
5. Plug the power cord in to an electrical outlet

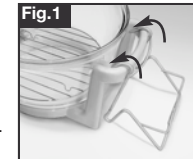

NOTE: HANDLE MUST BE PUSHED TO THE HORIZONTAL POSITION TO TURN OVEN ON. WHEN HANDLE IS IN VERTICAL POSITION, OVEN IS OFF.

Thermostat

6. Turn the thermostat knob clockwise to set thermostat to the desired temperature referring to "Quick reference Guide".
NOTE: During cooking time, when the oven reaches the preset temperature, it will shut off then it will start again automatically (this is normal).

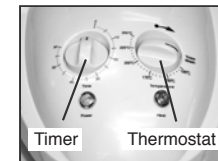

Timer: To Set Timer

7. Turn the timer knob clockwise to 60 min and then turn back to the desired time.
Note: Please allow time tolerance of 5-7 min for 60 min timer setting.
8. Push safety handle down (until you hear a click sound) to "ON" position.
9. When the timer reaches the end of the cooking cycle it will stop and you will hear a bell sound.



10. Remove the lid
CAUTION-ALWAYS PLACE THE LID ON THE LID HOLDER and make sure that the handle is in OFF position, as illustrated in fig. 3.

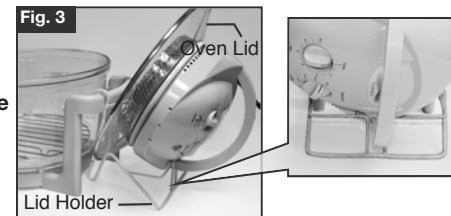

FlavorWave
OVEN™

TURBO

FlavorWave
OVEN™

TURBO

11. Now you can remove your food from the oven.
Remember, the food is hot inside the oven, pay extra attention.
Use the Tongs provided to remove the rack and food from the oven as illustrated in fig. 2.
12. Thaw Function: The Thaw setting allows thawing for delicate foods and particularly those items which require gentle defrosting. Rather than leaving them on a benchtop they may be defrosted in the closed hygienic environment of the Oven.



All glass surfaces of the oven get very hot. Touching these surfaces before oven cools will cause a burn. Do not touch any glass part of the oven until it has cooled down.

CLEANING YOUR OVEN



ALWAYS UNPLUG THE OVEN BEFORE CLEANING

LIGHT CLEANING

- Unplug oven and let cool.
- Use a sponge or dishcloth with a mild dish washing detergent and warm water to wipe glass bowl clean.
- Rinse well to remove all detergent.
- Note : Never immerse the lid in any liquid.

NORMAL CLEANING

- Unplug oven and let cool.
- Wipe lid and fan housing using a dishcloth or damp sponge with a mild dish washing detergent.
- Do not clean with steel wool pads or abrasive materials.
- Wash wire racks in mild dish washing detergent and water.
- Clean metal parts using a sponge or dishcloth with a mild dish washing detergent, then wipe clean. If scrubbing is necessary, use a nylon or polyester mesh pad.



DO NOT USE THE OVEN UNTIL IT'S COMPLETELY DRY

SELF CLEANING OF GLASS BOWL

- Add tap water, approximately 3.8cm (1.5"), until the water reaches the mark level on the bowl holder in fig.4.
- Add one squeeze of mild dish washing detergent.
- Replace lid and plug in.
- Set heat control to "wash" and set timer for 10 minutes.
(The hot air circulation creates the turbo action that helps release stubborn residue from bowl.)
- After cleaning rinse in warm water to remove all soap residue.



DISHWASHER-SAFE GLASS BOWL

The glass bowl and wire racks may also be washed in the dishwasher. However, never wash the lid in a dishwasher or immerse it in liquid. Remove the glass bowl from its stand before dish washing.

REMEMBER...

- Unplug oven before cleaning the lid
- Let oven cool before washing
- Never immerse lid in water
- Do not add water above the line marked on the glass bowl when self cleaning
- Do not let fan assembly get wet

DRYING THE OVEN

- The oven must always be kept dry after cleaning to avoid moisture in the lid.
- Make sure the oven is unplugged, leave lid slightly open and allow the oven to dry thoroughly as illustrated in fig.5.

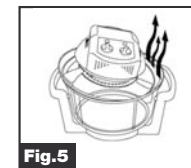

TO AVOID BREAKAGE ALLOW THE GLASS BOWL TO COOL BEFORE POURING WATER OR SELF CLEANING