



Distributed by: / Distribué par: / Distribuido por:

---

Thane Direct Canada Inc.  
Mississauga ON L4W 5M6, Canada  
[www.thane.ca](http://www.thane.ca)

Thane International, Inc.  
Canton OH 44718, U.S.A.  
[www.thane.com](http://www.thane.com)

Thane Direct UK Ltd  
London WC2A 3LH, UK  
[www.thane.tv](http://www.thane.tv)

Operadora Ainoa, S.A.P.I. de C.V.  
Avenida Tezozomoc # 292  
Colonia Petrolera  
Delegación Azcapotzalco  
C.P 02480  
México. D.F.  
[www.mejorcompratv.com](http://www.mejorcompratv.com)

Danoz Direct Pty Ltd  
Alexandria NSW 2015, Australia  
[www.danozdirect.com.au](http://www.danozdirect.com.au)

TVINS AB  
Skeppsbron 7  
211 20 Malmö, Sweden  
[www.tvins.com](http://www.tvins.com)

"Thane", "H2O", "PowerX" and related logos and variations are trademarks or registered trademarks, in the U.S. and/or other countries, of Thane International, Inc. and/or its subsidiaries.

Copyright © 2015 Thane International, Inc.  
MADE IN CHINA

H2O POWERX ENG R2 150702



H2O PowerX™



**USER'S GUIDE**  
MODEL No. KB-015, KB-015-1

# Thank You!

Congratulations on your choice of the H2O™ PowerX™ Steam & Vacuum Cleaner; a revolutionary new appliance, that combines a powerful Wet/Dry Vacuum and Steam Cleaner all in one in both upright and hand-held configurations.

The H2O™ PowerX™ Steam & Vacuum Cleaner is a new way of cleaning that is effective, easy and far more hygienic than conventional methods. By combining the Steam & Vacuum functions all in one, you increase your cleaning power and leave your home spotlessly clean, simply by converting water to steam and using a microfiber cloth to enhance absorbency. Dirt and grime can be eliminated in a matter of seconds.

Cleaning with the H2O™ PowerX™ Steam & Vacuum Cleaner is environmentally friendly, as it uses the active power of steam without the use of detergents. Regular steam cleaning also helps destroy dust mites, and some types of bacteria, fungus and mildew.

Thane Direct and its affiliated companies assume no liability for personal injury or property damage resulting from the misuse of the H2O™ PowerX™ Steam & Vacuum Cleaner, including the failure to comply with the instructions contained in this User's Guide or provided by the manufacturer or distributor of the treated surface.

## **IMPORTANT SAFETY INFORMATION**

READ ALL INSTRUCTIONS BEFORE USING THIS  
STEAM & VACUUM CLEANER

# Cleaning and Maintenance

**⚠ WARNING** DISCONNECT THE UNIT FROM THE POWER OUTLET FOR CLEANING AND MAINTENANCE. DO NOT IMMERSE THE H2O™ PowerX™ Steam & Vacuum Cleaner IN WATER.

## Cleaning procedure to remove lime scale:

If your H2O™ PowerX™ Steam & Vacuum Cleaner begins to produce steam slower than usual or stops producing steam you may need to remove lime scale. It is necessary to remove lime scale on a regular basis every 25 times you use a full tank of water or once a month, especially in areas with hard water.

To remove lime scale from the H2O™ PowerX™ Steam & Vacuum Cleaner, please follow these procedures:

## Using the Cleaning Pin:

Swirl and push the pin up and down the small hole of the steam outlet in the Main Body. Ensure that all scale debris has been removed from the steam outlet before reassembling.

## Using a cleaning solution:

1. Prepare a solution of 1/3 white vinegar and 2/3 water and add to the Water Tank.
2. Ensure that steam released is aimed away from the floor or surrounding objects. Plug the unit into a properly grounded electrical outlet, turn it ON and allow the unit to produce steam until the vinegar/water solution is used up.
3. Repeat the above procedure as many times as necessary until a normal steam flow is achieved.
4. Fill the Water Tank with fresh water and rinse out.
5. Fill the Water Tank with fresh water again, and release steam through the system until the Water Tank is empty.
6. Perform a test cleaning on a suitable isolated area after each lime scale removal to ensure that there is no debris left in the system.

Use detergent to clean the accessories when they are dirty. Wash with clean water and air dry.

## To clean calcium deposits building up inside the Water Tank:

Add 1-2 tablespoons of white vinegar to a full Water Tank, close the Water Tank Cap and shake the contents. DO NOT TURN THE STEAMER ON. Let the unit sit for a few hours. Empty the Water Tank and rinse with clean water until it rinses clear.

## Cleaning blocked steamer accessories:

Due to the high mineral content of water in some areas, some calcium buildup might develop inside the tip of the Jet Nozzle. To clean it, we recommend using a spray lubricant. Spray a small burst or two of the lubricant inside the tip of the Jet Nozzle. After spraying the lubricant, fill the steamer with water and run a continuous jet of steam through the affected accessory for several minutes to remove the deposit.

WE RECOMMEND PERFORMING THIS PROCEDURE IN A PROTECTED AND WELL-VENTILATED AREA.

## Microfiber Cloth care:

Machine wash at 60 °C (140 °F) / Do not bleach / Do not use fabric softener.

# Troubleshooting Guide

Problem	Possible Cause	Solution
The unit does not power on	The unit is not plugged in or turned ON	Make sure the unit is plugged into a properly grounded outlet and the switch is ON
Reduced steam or no steam	Water Tank is empty	Fill Water Tank
	Blocked Steam Nozzle	Remove Mop Head and clean the Nozzle
	Lime scale deposit	Follow cleaning procedure to remove lime scale
Steam escapes from connections	Attachment is improperly connected	Turn the unit OFF, allow it to cool down, detach the accessories and reattach them properly
	Debris or obstructions at the connection points	Remove the accessory and check and clean connection points
The cleaning cloth becomes wet	The cloth gets saturated with water after extensive use	Replace with a new cleaning cloth (optional item) or allow cloth to cool, wring out and reattach
Vacuum suction is reduced	Filters are dirty or clogged	Follow instruction on page 11 for cleaning the filters

# Contents

IMPORTANT SAFEGUARDS .....	3 - 4
KEY FEATURES .....	5
ACCESSORIES .....	6
OPTIONAL ACCESSORIES .....	6
HOW TO ASSEMBLE YOUR H2O™ POWERX™ STEAM & VACUUM CLEANER.....	7
INTRODUCTION TO YOUR H2O™ POWERX™ STEAM & VACUUM CLEANER.....	8
HOW TO USE YOUR H2O™ POWERX™ STEAM & VACUUM CLEANER .....	9 - 12
HOW TO ASSEMBLE THE HAND HELD UNIT .....	13
HOW TO USE THE HAND HELD UNIT .....	13
WATER FILTER .....	14
SAFETY PRESSURE RELEASE VALVE .....	14
AFTER USE .....	14
OPTIONAL ACCESSORY USAGE .....	15 - 16
CLEANING AND MAINTENANCE .....	17
TROUBLESHOOTING GUIDE .....	17

# Important Safeguards

**PLEASE READ ALL PRODUCT INSTRUCTIONS CAREFULLY. FAILURE TO FOLLOW THE PRODUCT INSTRUCTIONS WILL VOID YOUR WARRANTY.**

**USE YOUR H2O™ POWERX™ STEAM & VACUUM CLEANER ONLY AS DIRECTED IN THIS MANUAL AND ONLY WITH THE MANUFACTURER'S RECOMMENDED ACCESSORIES. USE OF ATTACHMENTS OR ACCESSORIES NOT PROVIDED OR SOLD BY THE MANUFACTURER OR BY AUTHORIZED RESELLERS MAY CAUSE FIRE, ELECTRIC SHOCK OR INJURY.**

**AS WITH ANY ELECTRICAL APPLIANCE, BASIC PRECAUTIONS SHOULD ALWAYS BE OBSERVED WHEN USING THIS PRODUCT, INCLUDING THE FOLLOWING:**

**⚠ WARNING TO REDUCE THE RISK OF FIRE, ELECTRIC SHOCK OR INJURY OBSERVE THE FOLLOWING:**

1. Verify that the main voltage indicated on the Rating Plate on this appliance corresponds with the voltage of your electrical outlet.
2. In order to protect against risk of electric shock, only plug this appliance into properly grounded outlets.
3. This appliance is designed for household use only. Do not use outdoors. Commercial use of the H2O™ PowerX™ Steam & Vacuum Cleaner voids the manufacturer's warranty.
4. Do not leave the H2O™ PowerX™ Steam & Vacuum Cleaner unattended while plugged in.
5. Close attention is necessary when used near children, pets or plants. Never direct steam towards people, animals or plants, as hot steam emission may cause scalding.
6. Do not allow the H2O™ PowerX™ Steam & Vacuum Cleaner to be used as a toy. Children should be supervised to ensure that they do not play with this appliance.
7. This appliance is not intended for use by persons with physical, sensory or mental impairments unless they are instructed and supervised during use by an able and experienced adult responsible for their safety.
8. Do not handle the plug or the H2O™ PowerX™ Steam & Vacuum Cleaner with wet hands or operate without shoes. Do not immerse the H2O™ PowerX™ Steam & Vacuum Cleaner in water or other liquids. The steam should not be directed towards equipment containing electrical components, such as the interior of ovens.
9. Do not use this appliance with a damaged cord or plug. If it is not working as it should, or if it has been dropped, damaged, left outdoors, or immersed in water, return it to the distributor. If the supply cord is damaged, it must be replaced by the manufacturer or a qualified repair facility to avoid hazard.
10. Never force the plug into an outlet or pull or carry the unit by the cord. Do not use the cord as a handle, close a door on the cord or pull the cord around sharp edges or corners. Keep the cord away from heated surfaces.
11. Do not use extension cords or outlets with inadequate current-carrying capacity, and in order to avoid circuit overload, do not operate another appliance on the same socket (circuit) as the H2O™ PowerX™ Steam & Vacuum Cleaner.
12. To disconnect the H2O™ PowerX™ Steam & Vacuum Cleaner, turn the Power Switch to the "OFF" position; then remove the plug from the outlet.
13. Unplug the unit after each use or before servicing. In order to safely unplug the unit, grasp the plug and gently pull. Do not unplug the unit by pulling on the cord.
14. Do not insert any objects into openings in the unit or use it with any of its openings blocked.
15. Store your H2O™ PowerX™ Steam & Vacuum Cleaner indoors in a cool and dry place. Never leave the H2O™ PowerX™ Steam & Vacuum Cleaner outdoors.
16. Keep your work area well lit and use extra caution when using on stairs.
17. Do not use the unit without water in the Water Tank, and do not use the Mop Head without first attaching the floor cloth.
18. Stop using the H2O™ PowerX™ Steam & Vacuum Cleaner if you observe water leakage, and contact a qualified technician.
19. Never put hot water or liquids such as alcohol-based or detergent products into the Water Tank. This will make operation unsafe and damage the unit.
20. Always keep the steam opening clear of any obstructions. Avoid placing the steam opening on soft surfaces to avoid blocking the flow of steam. Keep the steam opening free from lint, hair and other potential obstructions to ensure proper steam flow.
21. Do not use the H2O™ PowerX™ Steam & Vacuum Cleaner in spaces that are exposed to flammable, explosive or toxic vapor such as paint thinner or oil-based paint.
22. Do not use on leather, wax-polished furniture or floors, unsealed hardwood or parquet floors, unglazed ceramic floors, synthetic fabrics, velvet or other delicate steam-sensitive materials.
23. Do not use this appliance for space heating purposes or place it on or near hot surfaces such as a hot gas or electric burner, or in a heated oven.
24. Do not use this appliance for other than its intended use.

# Optional Accessory Usage

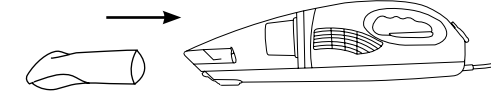
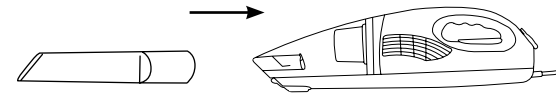
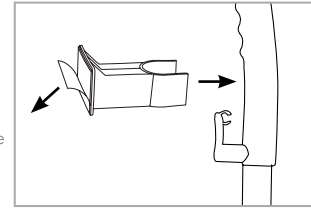
Part and Usage	Assembly	Tips/Caution
<b>LIQUID SUCTION TOOL</b> Use to clean up small liquid messes on carpet, floors or upholstery.		During the process of sucking up liquids, keep an eye on the level of liquid in the Storage Tank. Once the maximum fill line is reached (50ml), stop and empty the Storage Tank.
<b>CREVICE TOOL</b> Use in tight and narrow spaces, corners and along edges in areas such as dresser drawers, upholstered furniture, stairs and baseboards.		
<b>CARRY STRAP</b> Helps to carry the Hand Held unit, allowing one hand to operate the attached accessory, leaving the other hand free and allowing for easier movement as you clean.	<ol style="list-style-type: none"> <li>1. Undo the hook-and-loop fastener.</li> <li>2. With the shoulder strap on the top side of the Hand Held Unit, put the Hand Held Unit through the larger strap loop.</li> <li>3. Connect the hook-and-loop fastener to secure the Hand Held Unit in the Strap.</li> <li>4. Once the Hand Held Unit is securely placed in the Strap, adjust the length of the shoulder strap and place it on your shoulder</li> </ol>	Assure that the strap is not covering the Power Switch.
<b>STORAGE CLIP</b> Use to securely store the H2O™ PowerX™ Steam & Vacuum Cleaner.	<p>Locate the Storage Clip and remove the paper, being careful not to touch the adhesive surface. Place the Storage Clip at a height high enough to grab a hold of the handle as illustrated. Then press with a sufficient amount of force to hold it in place. When the unit is not in use, place the handle into the Storage Clip to ensure it is securely stored away.</p> 	

# Optional Accessory Usage

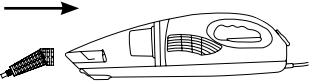
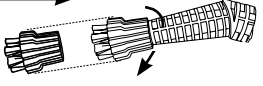
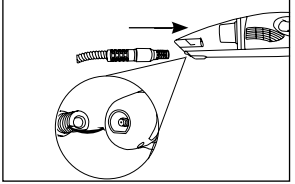
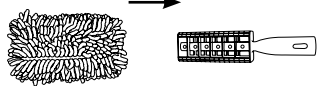
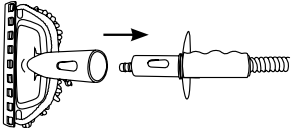
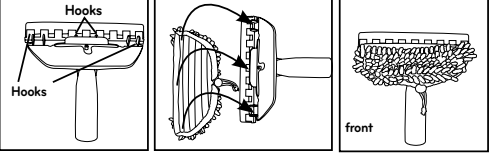
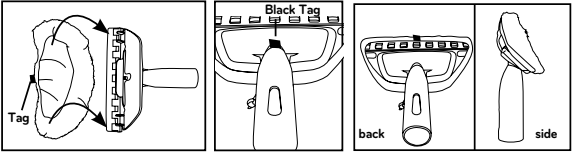
Part and Usage	Assembly	Tips/Caution
<p><b>BENT NOZZLE</b> Produces powerful steam for cleaning corners and gaps.</p>	<p>Insert the Jet Nozzle into the designated hole in the Main Body until it safely locks in place.</p> 	<p>Make sure the Jet Nozzle is securely locked in place before usage.</p>
<p><b>NYLON BRUSH/METAL BRUSH</b> The round nylon brush is great for cleaning smooth hard surfaces, such as toilets, sinks, and kitchen counters, etc. It can be used with soap or detergent to clean dirty areas. The Metal brush is great for cleaning coarse or metal surfaces, such as brick floors, car wheels, metal doors, and metal frames, etc.</p>	<p>Both brushes can be attached to any of the steam nozzles. Attach the brushes by screwing onto the threaded end of the Jet Nozzle.</p> 	<p>Use different color brush for particular cleaning areas (kitchen, bathroom, etc.)</p>
<p><b>EXTENSION HOSE</b> This 30" Extension Hose is designed for use with Hand-Held Steamer and with the following attachments: - Window Cleaning Tool - Duster - Bendable Jet Nozzle</p>	<p>Insert the designated end of the Extension Hose into the designated hole in the Main Unit until it locks in place.</p> 	<p>Make sure the Extension Hose is securely locked into place before usage. When in use, keep the Extension Hose away from your body and avoid touching the hose as it can get hot.  Do not pull the Extension Hose with excessive force, as it might cause damage and result in a steam leak.</p>
<p><b>DUSTER, WITH CORAL CLOTH</b> Slowly pass over surface to be cleaned. The absorbent Coral Cloth picks up the dirt loosened by the steam.</p>	<p>Install the Coral Cloth into the Duster frame and attach the Duster to the Extension Hose.</p> 	<p>Do not use steam setting 4 when using the Duster.</p>
<p><b>WINDOW CLEANING TOOL</b> Attached to the Extension Hose and in combination with one of the provided cleaning cloths or scraper, use this tool for window cleaning, garment steaming, wallpaper removal, etc.</p>	<p>Align the lock button on the Extension Hose with the designated hole on the Window Cleaning Tool Frame and push in the Extension Hose until it locks in place. Install cleaning cloth of your choice onto the Window Cleaning Tool.</p> 	
<p><b>WINDOW CLEANING CORAL CLOTH</b> Use it to clean windows, mirrors and glass.</p>	<p>Install the Coral Cloth over the Window Cleaning Tool. Do not cover the squeegee blade or scraper when installing the cleaning cloth.</p> 	<p>Do not use steam on frozen windows.  Be careful when using the steamer on glass, as the glass may break.</p>
<p><b>GARMENT STEAMING CLOTH</b> To steam a garment, place item of clothing on a hanger and steam the garment directly. Slowly slide the Garment Steamer Head vertically over the garment to smooth the fabric and remove wrinkles and odors.</p>	<p>Install the Garment Steaming Cloth / Lint Cloth / Microfiber Scrubbing Cloth over the Window Cleaning tool. Make sure to attach the cloth to all hooks on the Cleaning Tool Frame to avoid slipping from the frame during use.</p> 	<p>For garment steaming do not use steam settings 3 and 4.  Some fabric like leather, suede, and velvet may not be suitable for steaming. Please refer to the fabric manufacturer's label.  Curtains and draperies can be steamed while hanging.</p>

25. The following listed materials should not be suctioned up by the vacuum, otherwise it may damage the appliance, cause fire, or result in injury to individuals.
  - a. Hot materials, such as cigarette or coal ashes.
  - b. Large pieces of materials which can block air openings or get stuck inside the air flow chamber.
  - c. Poisonous, corrosive, or erosive materials (such as acids or detergents).
  - d. Any flammable or volatile liquid (such as gasoline or products containing alcohol).
  - e. Excessive or large amounts of liquid, dirt or dust which could exceed the "Maximum Dirt Level" line marked on the water container.
  - f. Hard or sharp objects such as glass, or metal objects such as pins, nails and paper clips.

FAILURE TO FOLLOW THESE INSTRUCTIONS MAY RESULT IN ELECTRICAL SHOCK, FIRE, DAMAGE TO THE PROPERTY OR SERIOUS PERSONAL INJURY AND EVEN DEATH.
26. Do not place appliance where it can fall or be pulled into water or other liquid.
27. Do not reach for an appliance that has fallen into water. Unplug immediately!
28. The H2O™ PowerX™ Steam & Vacuum Cleaner creates suction. Do not expose your hair, loose clothing, fingers or body parts to openings or moving parts.
29. Do not obstruct air flow openings or Air Vents of the of the H2O™ PowerX™ Steam & Vacuum Cleaner or place it on a soft surface, such as a bed or couch, where the air openings or Air Vents may be blocked.
30. Keep air openings free of lint, hair, debris or anything that may obstruct air flow. Do not use the H2O™ PowerX™ Steam & Vacuum Cleaner or any of the attachments with any opening blocked.
31. Do not lubricate any parts, or carry out any maintenance or repair work on the H2O™ PowerX™ Steam & Vacuum Cleaner or its accessories other than as shown in this User's Guide
32. It is recommended to empty the Dust Cup and to clean the filter after each use.

**SAVE THESE INSTRUCTIONS**

# Key Features

1. Handle
2. Curved Handle Lock Button
3. Cord Lock Slot
4. Upper Cord Wrap
5. Lower Cord Wrap
6. Power Supply Cord
7. Water Tank Cap
8. Extension Handle Lock Button
9. Water Filter
10. Water Tank
11. Power Switch
12. Main Body
13. Power Indicator Light
14. Dust Tank Filter
15. Dust Tank
16. Dust Tank Locking Pin
17. Safety Pressure Release Valve
18. Vac/Mop Head
19. Microfiber Cloth for Vac/Mop Head (x2)
20. Carpet Glider

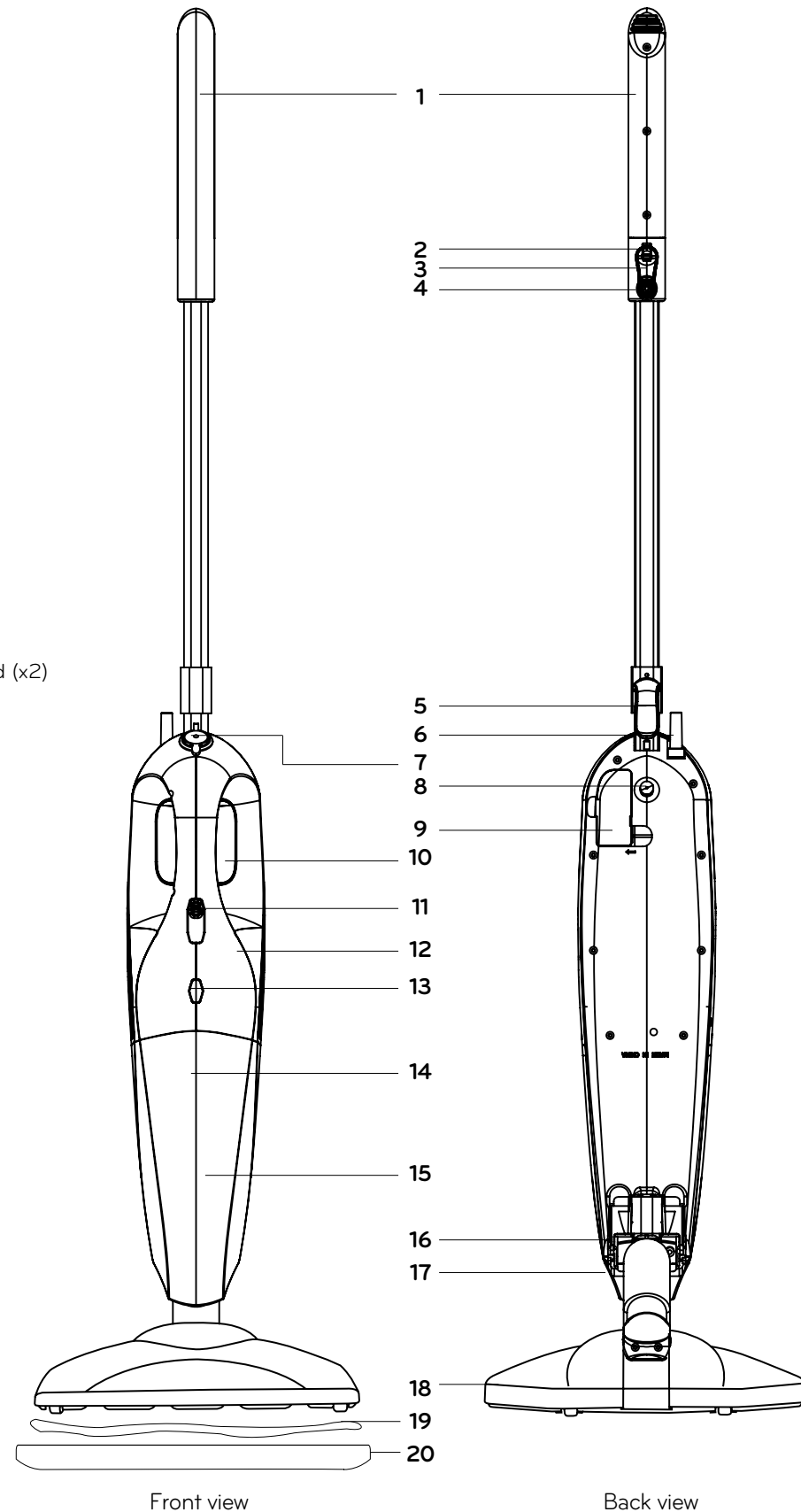

# Water Filter

It is important to replace the water filter every three to four months, or after every 20 to 25 uses, whichever comes first. The filter should also be replaced if it becomes visibly dirty. The Water Filter removes minerals and other impurities from tap water and also works to prevent water deposits from damaging your H2O™ PowerX™ Steam and Vacuum Cleaner.

To maximize the performance of your filter, distilled water may be used.

To replace the Water Filter, remove the Water Filter from the back side of the appliance, pulling the Water Filter from both sides (Fig. 1). Replace with a new H2O™ PowerX™ Water Filter and follow instructions for "How to use your H2O™ PowerX™ Steam and Vacuum Cleaner."

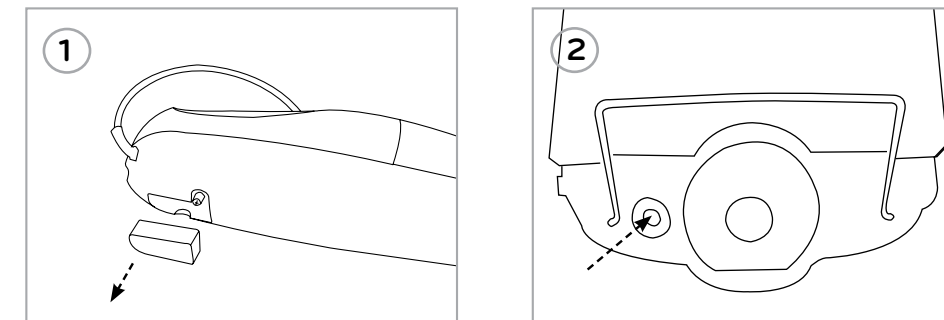

# Safety Pressure Release Valve

The Safety Pressure Release Valve is designed to relieve pressure inside the water heater by discharging hot steam or water through the Safety Pressure Release Valve if the steam nozzle becomes blocked due to lime scale build up. The Safety Pressure Release Valve is located next to the steam nozzle on the main body (Fig. 2).

## ⚠ WARNING

Steam or water discharged from the Safety Pressure Release Valve can be very hot. At all times during use, make sure to keep body parts clear of the Safety Pressure Release Valve to avoid being burned by hot steam or water in the event of discharge.

Discharge of steam or water from the Safety Pressure Release Valve is an indication of an abnormal condition. In such case, immediately stop using the H2O™ PowerX™, turn it off and unplug it from the outlet. Let the unit cool down and clean the steam nozzle according to the Cleaning and Maintenance section in this User's Guide. Once the lime scale has been removed, the Safety Pressure Release Valve will no longer discharge steam or water and the unit will begin to produce steam normally.

## NOTE

It is very important to remove lime scale on a regular basis. During normal operation, no steam or water should be discharged from the Safety Pressure Release Valve.

# After Use

1. Press the Power Switch to OFF.
2. Unplug Power Cord from the electrical outlet.
3. Make sure to remove the Mop Pad/Cloth before storage. Allow it to cool down and carefully remove the cloth.
4. Always empty the Water Tank at the end of each use.
5. Drain left-over water or steam before storing.
6. Wrap Power Cord around Upper and Lower Cord Wrap.
7. Wipe all surfaces of the H2O™ PowerX™ Steam & Vacuum Cleaner with a soft cloth.
8. Store in a protected and dry area.
9. Securely store the unit by using the Storage Clip and following the instructions on page 16.

# How to Assemble the Hand Held Unit

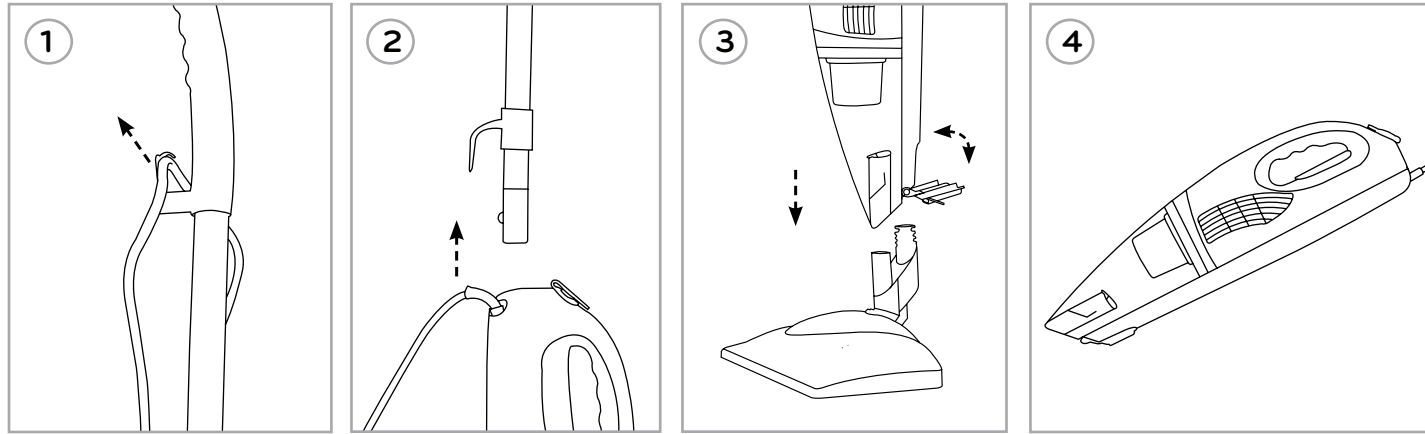

The Hand Held Unit is an ideal portable cleaner for spot cleaning and vacuuming floors, carpets, rugs, furniture and work surfaces such as countertops, sinks and tiles. To use simply detach the Extension Cord from the Cord Holder on the handle, remove the Extension Handle as well as the H2O™ PowerX™ Steam & Vacuum Cleaner Head.

### To Assemble the Hand-Held Unit:

Follow Step 1, to release the Power Supply Cord

Follow Step 2, to release the Extension Handle

Follow Step 3, disconnect the Vac/Mop Head by releasing the clip on the backside of the unit and removing it from the Main Body.

Connect the Dust Tank Locking Pin to the Dust Tank and then click the clip back into place to secure the head.

Attach one of the Hand Held accessories

**CAUTION** Make sure H2O™ PowerX™ Steam & Vacuum Cleaner is unplugged before assembly.

# How to Use the Hand Held Unit

The Hand Held unit is designed to thoroughly clean and help sanitize many of the surfaces in your home without harsh chemicals. Whether it's the bathroom or kitchen, nursery or backyard grill – now you can GREEN CLEAN with multiple steam settings and a powerful vacuum that make the H2O™ PowerX™ Steam & Vacuum Cleaner great for virtually any cleaning job.

### For Vacuum Function:

Attach either the Crevice Tool (Dry Messes) or the Suction Tool/Brush (Wet Messes) to the Hand Held Unit.

Once the unit has been fully assembled, plug the Power Cord into a grounded electrical outlet.

Turning the unit ON:

Red Light will turn on indicating that the power is on. Power Switch button is still in the OFF position. Move the Power Switch to the "Vac" setting.

Hold the Hand Held unit and proceed with vacuum cleaning by moving the suction opening of the H2O™ PowerX™ Steam & Vacuum Cleaner accessory in a close proximity over the area or object to be vacuumed in an even and slow manner.

### For Steam Function:

Fill the Water Tank with water (refer to the "HOW TO USE H2O™ PowerX™ Steam & Vacuum Cleaner" section in this manual) and select and attach one of the available attachments (please refer to the "ACCESSORY USAGE" section in this manual). Select one of the Steam Function Settings. Use Low Setting for sensitive surfaces such as Upholstery, Mattresses and Pillows. Use High Setting for tougher stains on Carpets & Door Mats.

### NOTICE

- Do not use the Hand-Held Unit to clean frozen windows.
- Be careful when using the Hand-Held Unit on glass, as the glass may break.

# Accessories

1. Bent Nozzle
2. Nylon Brush
3. Metal Brush
4. Crevice Tool
5. Liquid Suction Tool
6. Cleaning Pin
7. Storage Clip

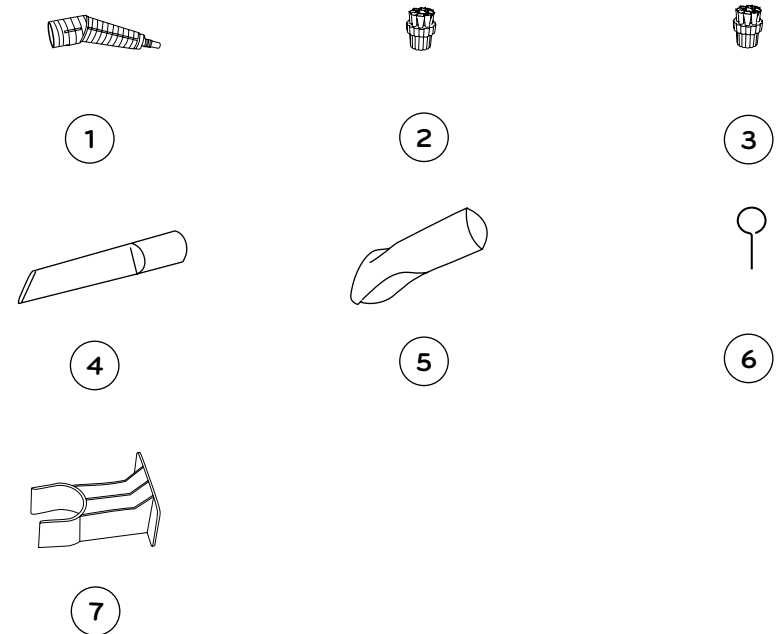

# Optional Accessories

8. Window Cleaning Tool
9. Coral Cloth for Window Cleaning Tool
10. Microfiber Cloth for Garment Steamer
11. Extension Hose
12. Coral Cloth
13. Scrubbing Cloth
14. Carry Strap

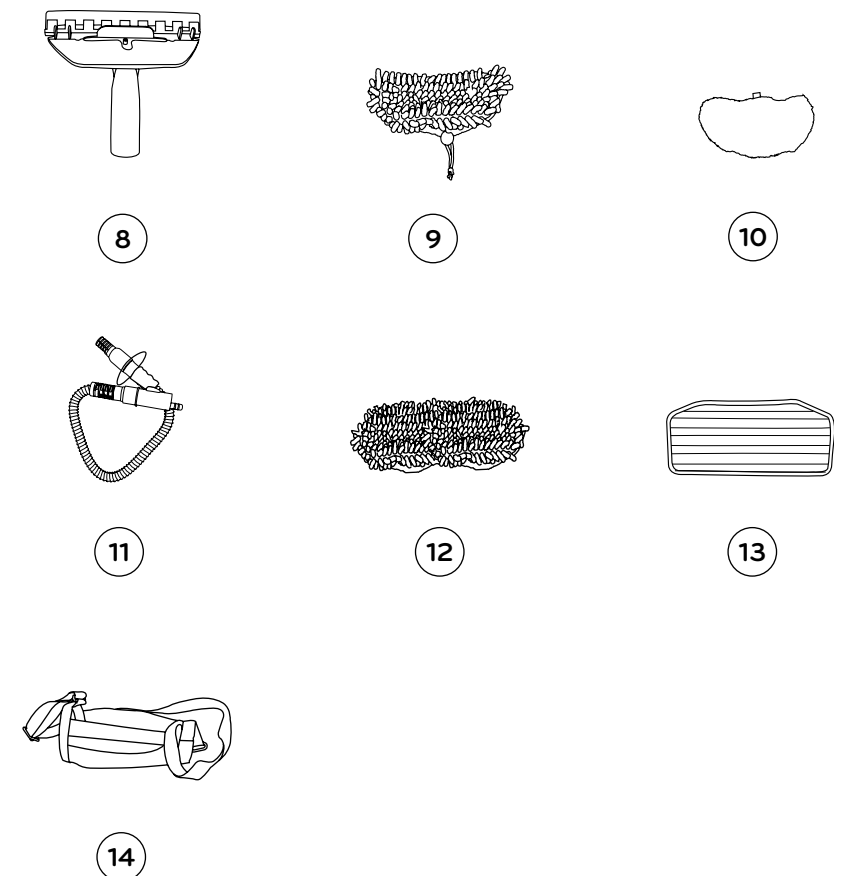

# How to Assemble Your H2O™ PowerX™ Steam & Vacuum Cleaner

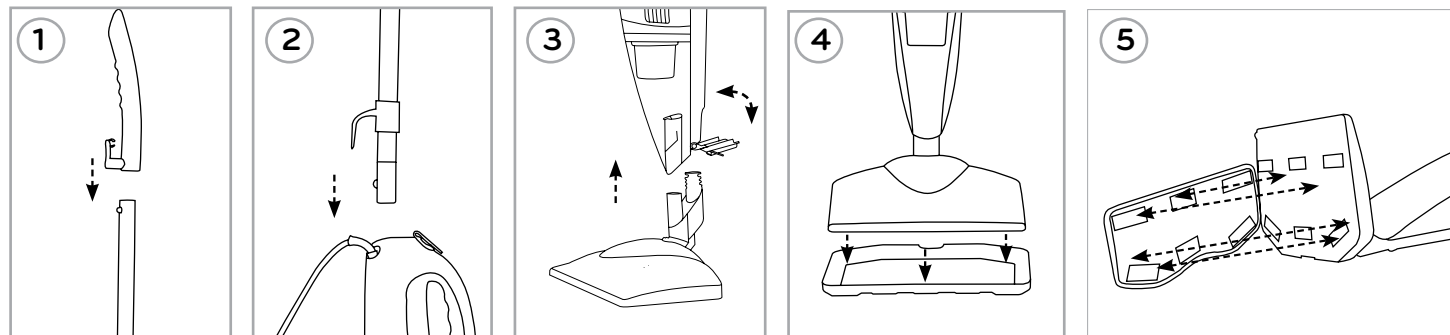

Start the assembly of your H2O™ PowerX™ Steam & Vacuum Cleaner by completing steps 1, 2, and 3.

**Step 3:** Connect the Vac/Mop Head by releasing the clip on the backside of the unit and inserting it into the unit. Connect the Dust Tank Locking Pin to the Dust Tank and then click the clip back into place to secure the head.

#### For Vacuum Function:

**Step 4:** When using the H2O™ PowerX™ Steam & Vacuum Cleaner on carpeting or rugs: Place the Mop Head on top of the Carpet Glider (as illustrated in Fig. 4).

**Note:** The Carpet Glider is not needed for low-pile carpets or thin area rugs and mats.

**Note:** For optimal performance of the vacuum, the Microfiber Cloth should be removed.

#### For Steam Cleaner Function:

**Step 4:** Attach the Microfiber Cloth by placing the cloth under the Mop Head and align fastening strips of the cloth with the gripping strips on the bottom of the Mop Head (as illustrated in Fig. 5). Press to fit together.

**Step 5:** When using the H2O™ PowerX™ Steam & Vacuum Cleaner on carpeting or rugs: Place the Mop Head, with Microfiber Cloth in place (for Steam Cleaning), on top of the Carpet Glider (as illustrated in Fig. 4). Do not attempt to use the H2O™ PowerX™ Steam & Vacuum Cleaner on carpeting or rugs without the Carpet Glider in place when steam cleaning.

**Note:** Replace the Microfiber Cloth under the Mop Head if it gets dirty. Follow the instructions "For Best Results" on the bottom of page 12.

**WARNING** Never use the Carpet Glider on surfaces that are prone to scratching.

**CAUTION** Make sure that the unit is unplugged from an electrical outlet and the Power Switch is in the "OFF" position before assembling the unit or changing the accessories.

# How to Use Your H2O™ PowerX™ Steam & Vacuum Cleaner

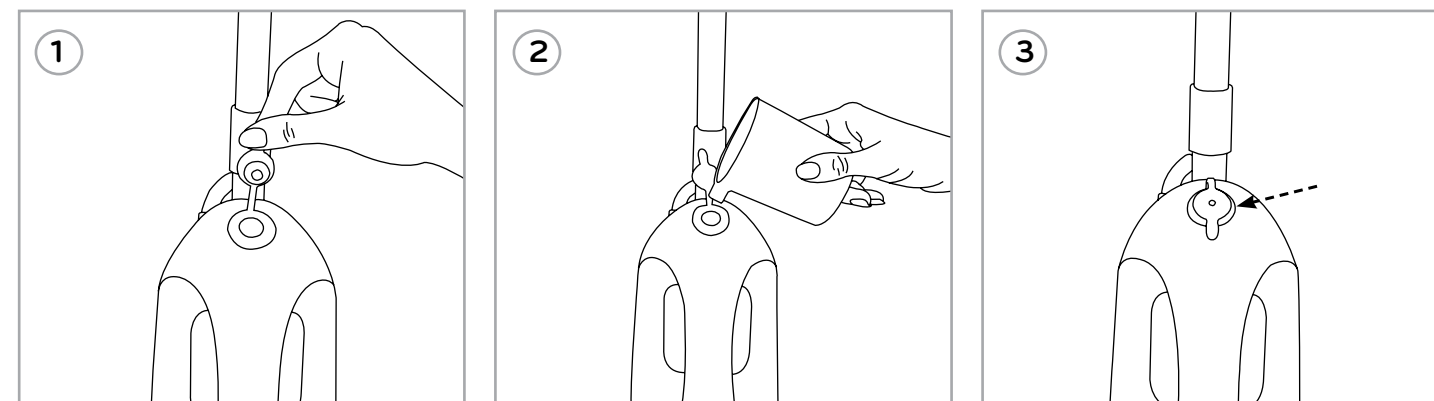

## STEAM FUNCTION

#### To fill the Water Tank:

Ensure that the H2O™ PowerX™ Steam & Vacuum Cleaner unit is unplugged. Open the Water Tank cap by gently pulling on the cap. Add water by using the measuring cup. Do not overfill. Tank capacity is 300ml/10 oz. Replace the Water Tank cap, ensuring it is fully pushed in. Make sure the Copper Cone inside the Water Tank is always submerged in water while operating the unit. Never put cleaning detergents into the Water Tank. Unless approved by the manufacturer, do not put any scented products in the Water Tank. The H2O™ PowerX™ Steam & Vacuum Cleaner uses tap water, but in areas with hard water use distilled water for better performance.

Once the unit has been fully assembled and filled with water, place the Microfiber Cloth onto the Head (Fig. 1) then plug the Power Cord into a grounded electrical outlet.

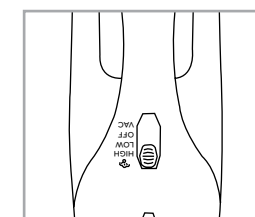

#### Turning the unit ON:

1. Red Light will turn on indicating that the power is on. Power Switch button is still in the OFF position.
2. Move the Power Switch button to one of the Steam Function settings "High" or "Low". Wait approximately 20-30 seconds for the heater to warm up and Steam to begin to emit.
3. To stop emitting steam, move the Power Switch to OFF.

#### NOTE

Make sure to turn the unit OFF after each use and then disconnect it from the electrical outlet.

#### Select one of the Steam Regulator Positions:

**Low:** Ideal for cleaning all hard floors, such as linoleum, ceramic, granite and marble, sealed hardwood, tiles, slate, etc., as well as garments and fabrics.

**High:** Ideal for cleaning carpets and rugs, and for cleaning in bathrooms and kitchens.

#### Start Cleaning:

Slowly pass over the surface to be cleaned. The absorbent mop cloth picks up the dirt loosened by the steam. Apply steam as needed. When the H2O™ PowerX™ Steam & Vacuum Cleaner stops producing steam, simply turn it OFF, unplug it from the electrical outlet and refill the Water Tank to continue cleaning.

#### For Best Results:

1. Vacuum the floor prior to using the Steam function.
2. To avoid puddling of water, the Microfiber Cloth must be clean and dry for use. To replace the cloth, proceed as follows: Let the cloth cool down, remove cloth from unit, replace with a new Microfiber Cloth (optional item) and continue use. Select Low Steam power level.
3. To help sanitize an area of your floor, leave the H2O™ PowerX™ Steam and Vacuum Cleaner at a High Steam power level over the area for about 10 seconds, but no longer than 15 seconds.

Do not carry out this procedure on heat and steam sensitive floors.

- Never steam on one spot for too long. This can cause floor surface damage.
- Do not put hands or feet under the steam mop. Unit gets very hot.
- During use a pulsing noise may be heard indicating that the mop is producing steam. This noise is normal.
- There may be some minor "spitting" of water mixed with the steam. This is also normal.
- The force and heat of the steam may adversely affect certain materials. Always check the suitability of using steam on a surface by carrying out a preliminary test on a hidden area.



# How to Use Your H2O™ PowerX™ Steam & Vacuum Cleaner

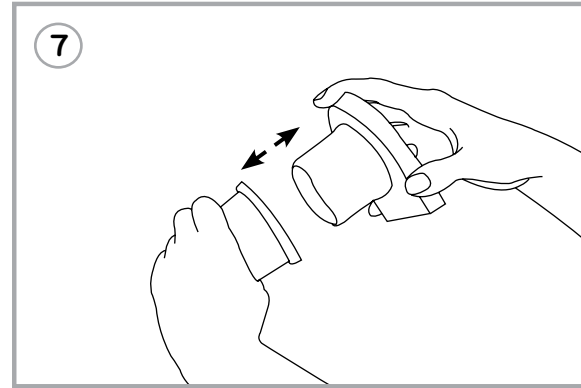
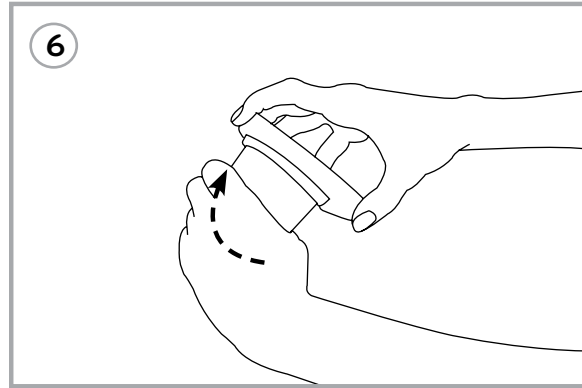

## CLEANING THE FILTERS

On a regular basis, clean the Mesh and Fabric Filters to dispose of dust and debris and to maintain the suction power of the H2O™ PowerX™ Steam & Vacuum Cleaner.

### Cleaning the Plastic Filter:

- Disconnect the Plastic Filter from the Filter Plate by twisting the Filter Plate counter-clockwise while pulling it away from the Plastic Filter (see 6 & 7).
- Shake out and dispose of dust and debris lodged in the Filter.
- To remove stubborn dirt, use a small brush.
- Rinsing the Filter under luke warm water may be necessary.

### Cleaning the Fabric Filter:

- Shake out and dispose of dust and debris lodged in the Filter.
- Use a small brush to remove dust and debris from the Fabric Filter.
- Should the Fabric Filter become soiled, it can be rinsed or gently hand washed in luke warm water. Air dry and do not use hot air blowers such as a hair dryer for drying.
- Do not wash the filters in a washing machine.

## CLEANING THE DUST TANK

If dirt or liquid are present after emptying the Dust Tank, it is necessary to clean the Dust Tank and all of the connections.

- Remove the Dust Tank (following instructions on page 10), then wipe the Dust Tank and all connections with a dry paper towel.
- If dirt is still present, fill the Dust Tank with warm soapy water and rinse until clean. Dry off with a paper towel or cloth before using again.

# Introduction to Your H2O™ PowerX™ Steam & Vacuum Cleaner

The H2O™ PowerX™ Steam & Vacuum Cleaner is designed to thoroughly Vacuum any type of flooring and Steam clean floor surfaces, such as marble, ceramic, carpet, stone, linoleum, sealed hardwood floors and parquet.

Test the H2O™ PowerX™ Steam & Vacuum Cleaner steam function on a small isolated area of your flooring prior to overall use on floor surfaces. The heat and steam action may remove the wax on surfaces treated with wax. Do not let unit stand on any wood or heat-sensitive floors for an extended period of time. Water marks, discoloration or damage to the floor surface can occur if the unit is left operating too long in one place. When using on vinyl, linoleum or any other heat-sensitive floors, use extra caution. Too much heat can melt glue in the flooring. Use only on laminated flooring that has been laid professionally and without any gaps or cracks that would permit the entry of moisture. Not all floor types are suitable for steam cleaning. Always check the use and care instructions of your flooring manufacturer or distributor before using the H2O™ PowerX™ Steam & Vacuum Cleaner. When in doubt, consult a flooring specialist.

### For Best Results:

- Use the vacuum function to clean dust and debris from the surface prior to using the steam cleaner function.
- To avoid accumulation of excess water, the Microfiber Cloth must be clean and dry before use.

### ⚠ IMPORTANT

- Never steam in one spot for too long.
- Do not put hands or feet under the steam mop.
- It is normal to hear a pulsing noise during use, indicating that the mop is producing steam.
- There may be some minor "spitting" of water mixed with the steam. This is normal.

# How to Use Your H2O™ PowerX™ Steam & Vacuum Cleaner

## VACUUM FUNCTION

### Dry Messes

Ensure that the filter is fitted into the Dust Cup and that the Dust Cup is securely clipped onto the Main Unit. Once the unit has been fully assembled, plug the Power Cord into a grounded electrical outlet.

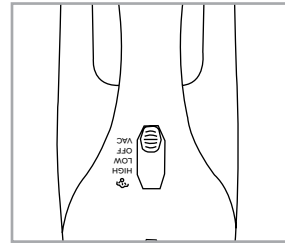

#### Turning the unit ON:

Red Light will turn on indicating that the power is on. Power Switch button is still in the OFF position. Move the Power Switch to the "Vac" setting.

Hold the handle and proceed with vacuum cleaning by moving the suction opening of the H2O™ PowerX™ Steam & Vacuum Cleaner Head in a close proximity over the area or object to be vacuumed in an even and slow manner.

When the Storage Tank has reached its maximum capacity (indicated by Max Fill Line) stop and slide the Power Switch "Off" and then empty the Storage Tank (see Emptying the Storage Tank).

### Wet Messes

The H2O™ PowerX™ Steam & Vacuum Cleaner is designed to lift liquids and clean soiled areas from carpets, upholstery and hard surfaces. Once the unit has been fully assembled, plug the Power Cord into a grounded electrical outlet.

#### NOTE

For optimal performance cleaning up wet messes, use the Hand Held function with the Liquid Suction Tool.

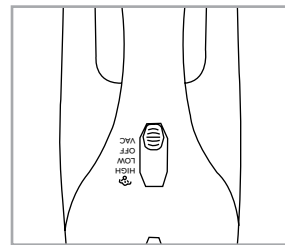

#### Turning the unit ON:

Red Light will turn on indicating that the power is on. Power Switch button is still in the OFF position. Move the Power Switch to the "Vac" setting.

Hold the handle and proceed with vacuum cleaning by moving the suction opening of the H2O™ PowerX™ Steam & Vacuum Cleaner Head in a close proximity over the area or object to be vacuumed in an even and slow manner.

When the Storage Tank has reached its maximum capacity (indicated by Max Fill Line) stop and slide the Power Switch "Off" and then empty the Storage Tank (see Emptying the Storage Tank).

**Tip:** For optimal vacuum performance, the Microfiber Cloth should be removed. If the Microfiber Cloth gets dirty, replace with a clean one prior to steam cleaning.

#### NOTE

It is recommended to empty the Storage Tank of all liquid or dirt and debris when switching from a dry mess to a wet mess or vice versa. The Storage Tank has a 50ml maximum for Wet messes, vacuuming past this indicated mark may cause leakage.

**WARNING** Before cleaning upholstery, check the manufacturer's tag on the furniture to see if it is safe to proceed.

**WARNING** When using the H2O™ PowerX™ Steam & Vacuum Cleaner for wet messes keep the unit between the positions in Fig.1. Once liquid has been vacuumed into the Storage Tank, DO NOT turn the unit in an upright position or tilt it backwards or lay it on its side (as shown in Fig. 2, 3, 4) as liquid may leak from the Storage Tank.

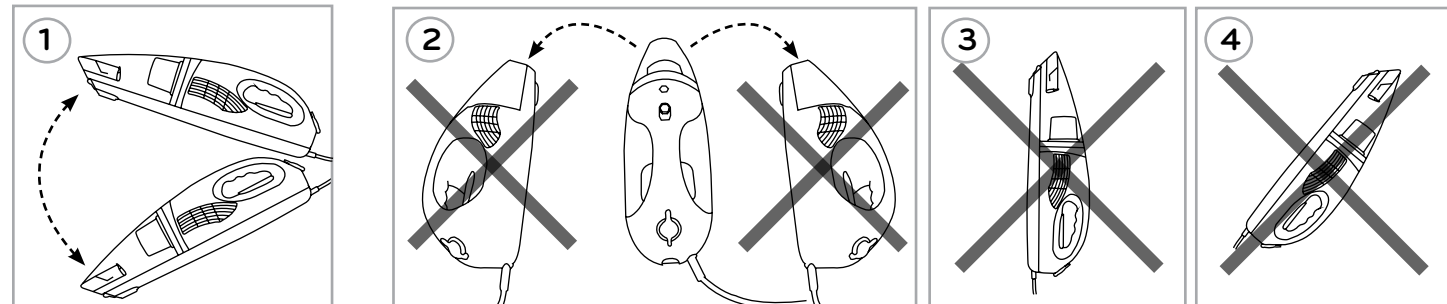

**WARNING** While using the H2O™ PowerX™ Steam & Vacuum Cleaner for wet messes, if any liquid leaks from the Storage Tank, immediately turn the unit off and investigate the cause of the problem. (see Disposing of Dirt and Liquid)

# How to Use Your H2O™ PowerX™ Steam & Vacuum Cleaner

### Disposing of Dirt and Liquid:

For best performance and to maintain suction power, it is important to empty and clean the Storage Tank, Plastic Filter and Fabric Filter after use. The Storage Tank is transparent, allowing you to see how much dirt and liquid has accumulated inside the Storage Tank. Dirt should be emptied when it has reached a level close to the Plastic Filter. Liquid should be emptied when the volume reaches the "MAX" level line (50ml).

#### NOTE

It is recommended to empty the Storage Tank of all liquid or dirt and debris when switching from a dry mess to a wet mess or vice versa.

#### WARNING

Do not accumulate so much dirt inside the Storage Tank that the Plastic Filter becomes covered or immersed.

**Tip:** Regular cleaning of the Storage Tank, Plastic and Fabric Filters will ensure efficient performance and increased lifespan of your H2O™ PowerX™ Steam & Vacuum Cleaner.

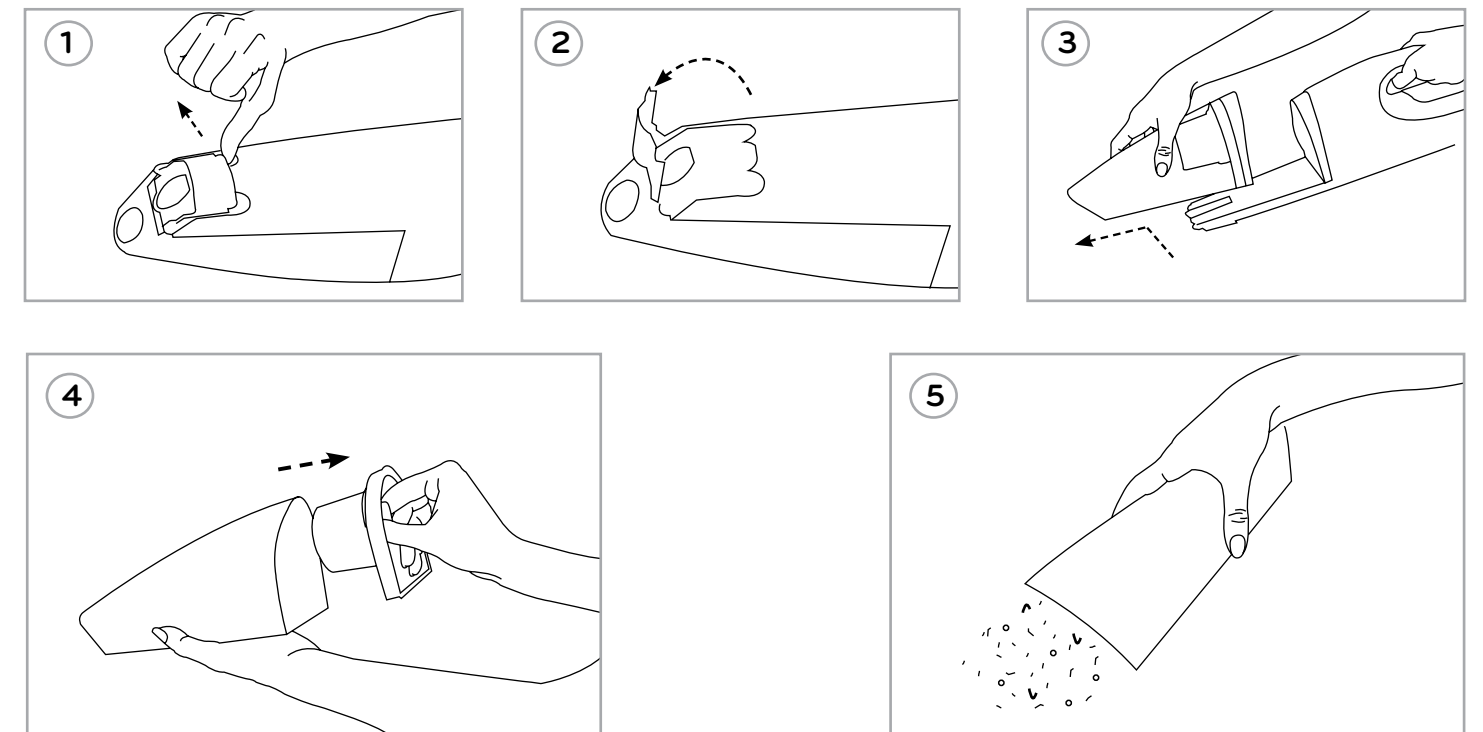

### Emptying the Storage Tank:

Slide the Power Switch to "OFF".

Disconnect the Main Unit Head or any other accessory from the Storage Tank.

Unlatch the Storage Tank Lock located on the backside of the Main Unit and remove the Metal Pin from the underside of the Storage Tank (Fig. 1&2).

Remove the Storage Tank from the Main Unit (Fig. 3).

Pull the Filter Plate (with Plastic and Fabric Filters) out from the Storage Tank (Fig. 4).

Empty dust and debris from the Dust Cup into a waste container (Fig. 5).

#### IMPORTANT

Take care when disconnecting the Dust Tank from the Main Body to ensure that the Filter Plate does not fall out.